



# SCC38000TM

## SANY Crawler Crane

### 2200 Tons Lifting Capacity

Quality Changes the World



**Max. lifting moment: 38000t·m**  
**Max. length of boom: 168m**  
**Max. length of boom + jib: 108m+108m**

**Preliminary data, after experimental verification, there will be a small change.**  
The parameters, pictures and standard/optional equipment are only for reference in this brochure, the actual machine is based on the effective price list and contract.



**Crawler Crane Series**  
**SCC38000TM**

P03

Main  
Characteristics

- Product Specification
- Safety Devices

P10

Technical  
Parameters

- Main Performance Parameters
- Outline Dimension
- Transportation Dimensions

P23

Configurations

- Boom Combination
- HDB Configuration
- LJDB Configuration
- HDB\_SY Configuration
- FJDB\_7 Configuration
- LJDB\_SY Configuration
- FJhDB Configuration



**SCC38000TM**  
**SANY CRAWLER CRANE**  
**2200 TONS LIFTING CAPACITY**

QUALITY CHANGES THE WORLD

## Main Characteristics

- Page 04 Product Specification
- Page 08 Safety Devices



## Product specification



### Module design

- Module design of transport unit can ensure the good combination of the mechanical system, electronic system and hydraulic system, realizing quick connection between modules.

### High-strengthened steel plates

- The high-strengthened steel plates is adopted for main structure welded and the pendant bars, so the transport weight of single piece is well controlled and cross-section of pendant bar reduced.

### Power unit in standard container

- All power system, control system, hydraulic system and cab are laid compactly, in a standard container, so the maintenance and transport are convenient and easier.

### The generator unit

- The generator unit of 220V can provide power for the air conditioner in the cab and the whole illumination system.

### Safe control system

- The work model and assembly model are easy and reliable. The in-time bearing pressure display, level indicator, function lock, emergency electrical control, lightning protection, autotravel-aligning, closed-circuit monitor and other safe and control systems are all fitted to ensure safety.

### New materials

- The aluminum alloy is used for walk pedals on the booms and rotating bed, so the boom weight is reduced and larger loading capacity possible.

### New technology

- The traditional lifting cylinder for superlift counterweight is replaced by accurate calculation. The utilization rate of superlift counterweight is also achievable before leaving the ground.

### Large lifting capacity

- The max. lifting capacity is 2200t, max. lifting moment 38000t-m, longest boom 168m, max. luffing jib combination 108m+108m.

### Convenient maintenance

- The time for access to the part to be adjusted is no longer than 10 min/person. That for the part needing daily maintenance is no longer than 30 min/person. That for the part needing service is no longer than 2 hours/person. And the remote monitoring system helps to make the maintenance and management easier.

### Travel with 100% load

- Four-wheel drive with powerful traction force brings steady travel, showing the very advantages of the crawler crane.

### Wireless control device

- The wireless remote control is achievable for assembly of carbody transverse beam, crawlers and rotating bed.



## Product specification

### Engine

- Two six-cylinder, water-cooling, turbo charged Weichai WP13 engines are arranged in parallel.
- Rated power: 390kW.
- Rated engine speed: 2100rpm.
- Max. output torque: 2300N.m/(1200-1600)rpm.
- A diesel of 2000L tank is offered.

### Electric system

- Crawler cranes of SCC series adopt integrated control system of distributed bus communication.
- The advantages: ① CAN transmission is the most suitable bus for engineering machinery. ② The distributed arrangement + integrated control simplify the whole circuit and enhance reliability. ③ A number of CAN smart nodes make the whole system more advanced.

### Hydraulic system

- Hydraulic system includes load hoist hydraulic system, traveling hydraulic system, swing hydraulic system, boom/jib luffing hydraulic system, servo hydraulic system, back-stop hydraulic system, cooling system, auxiliary hydraulic system. The main hydraulic components are of star brand.
- Characteristics: The main system adopt closed circuit, featured by energy saving, high efficiency, quick response, low heat radiation and long service life. The electrical proportional control.
- Components is widely adopted to facilitate the accurate and intelligent control. The hydraulic system is also fitted with pressure warning and filter clogging warning, improving the reliability. The electric system can automatically respond in time to circuit explosion. And additionally, the explosion relief valves are fitted in the hydraulic pipe to eliminate the damage, enhancing the safety.

### Swing system

- Swing part: Driven by four motor gearbox.
- Swing speed: 0~0.82r/min.
- Features: Steady swing, free slipping function and 360° rotation.
- Swing bearing mechanism: High performance six-row roller bearing.

### Main load hoist mechanism

- Adopt well-known brand components to control the main and aux. load hoist, to lift and lower the load. The rope speed of hoisting winch can be steplessly adjusted from 0~121m/min, with good inching performance. The quick promote of power can be realized at high speed. The wire rope is from famous brand. The multilayer winding of rope-folding drum ensures no rope disorder. The enclosed gear box is featured by low noise, high efficiency, and long service life.

Main load hoist winches	Drum diameter	870mm
	Rope speed of the outmost layer	0~121m/min
	Diameter of wire rope	40mm
	Rope length	1800m
	Rated single line pull	36.7t

### Boom luffing winch mechanism

- Components: Boom luffing mechanism, jib luffing mechanism, superlift luffing mechanism.
- The fold-line drums of winches, concealed reducer and closed circuit are adopted. The power supply is switched by directional control valve, realizing a number of compound actions and stepless speed adjustment, with good inching performance. Hydraulic control normally closed pawl locking device is equipped.

Boom hoisting mechanism	Drum diameter	830mm
	Rope speed of the outmost layer	0~58.3m/min
	Diameter of wire rope	40mm
	Rope length	410m×2
	Rated single line pull	36.7t

Jib luffing mechanism	Drum diameter	870mm
	Rope speed of the outmost layer	0~85.2m/min
	Diameter of wire rope	40mm
	Rope length	1300m
	Rated single line pull	36.7t

Superlift luffing mechanism	Drum diameter	870mm
	Rope speed of the outmost layer	0~98.1m/min
	Diameter of wire rope	40mm
	Rope length	1850m
	Rated single line pull	36.7t

## Product specification



### Counterweight

- Carbody counterweight: Total weight: 89t, counterweight block×8, counterweight tray×2.
- Rear counterweight: Total weight: 340t, counterweight block×28, counterweight tray×2.
- Superlift counterweight: Total weight: 1160t, counterweight block×109, counterweight tray×1.

### Cab

- The cab is located at the front part of the power system container. It is featured by fully-enclosed steel frame structure, large area of toughened glass window at front and sides, and the GE panel at top, making the cab brightened, strengthened and hard-wearing. The noise inside is lower than 85dB. And the interior control device, detecting instruments, fire alarming device and closed circuit are all the ergonomically designed and arranged.

### Control system

- The LML display, closed circuit monitor, monitoring screen and dashboards are all directly visible to the operator. The LML detects the lifting moments and other parameters. The monitor screen displays the crane's operation and the alarming data from the monitoring cameras. Inside the right and left armrest boxes are three control levers and their control functions switched over by monitoring keys. The simple actions and compound actions are displayed by words and pictures.

### Alarming

- Once a failure appear, all alarming data such as wind speed, water temperature, oil and fuel temperature, oil pressure and volume, working hours and engine speed will bounce up on the display.

### Travel drive

- Two stages of speed is available. With powerful traction force, the crane can travel with 100% load. Each travel device can be independently driven and flexibly move forward and backward, and turn in pivot.

### Travel brake

- The normally-applied travel brake is fixed in the gear box (The brake keeps workable before travel lever moved). And the brake is self-compensating, needing no adjusting. When the levers is operated, the brake release, and the travel system start to work.

### Track pad

- The track pads are 2000mm wide, and the total is 160pcs×2. The tension can be adjusted through hydraulic adjusting cylinder fixed in the crawler travel device, or through inserting spacer between crawler frame and the track adjusting cylinder.

### Transverse beam

- Welded structure of high-strengthened steel, the transverse beam is connected to crawler frame and carbody by power pins of hydraulic cylinder, enabling easy assembly & disassembly.

### Carbody and adapter

- The carbody and adapter are connected through bolts, improving the swing bearing connection. The adapter is connected with the rotating bed through power pins, the high-strengthened welded structure and transverse beam by power pin of hydraulic cylinder, easy for assembly and disassembly.

### Rotating bed

- It includes the front and the rear part, connected by power pin, independently transportable. The rear can be transported together with A frame, boom hoisting mechanism as a whole, cutting the time for the rope assembly & disassembly.

### Travel speed

- The variable displacement motor can realize two stages of speed. The speed can be steeplessly adjusted within the stage,
- high speed 0~0.76km/h, low speed 0~0.38km/h, ensuring steady travel.



## Product specification

### Operation equipment

- The operating equipment is made of high-strength steel tubes and high-strength steel plates, and the rolled welded pulleys are adopted on the boom head and hook.

### Boom

- The boom is a spatial lattice structure of welded tubes with equal section areas of inserts and tapered sections for two ends. The boom top and root are strengthened with steel plates, which is easier for load transfer.
- The boom length is 54m (basic boom) to 120m.
- Compositions: Boom base 10m, insert 6m×2, insert 12m(45)×2, insert 12m(40)×2, insert 12m(36)×3, transitional section of boom 12m, boom tip 2m.

### Luffing jib

- The luffing jib is a spatial lattice structure of welded tubes with equal section areas of inserts and tapered sections for two ends. The jib top and root are strengthened with steel plates, which is easier for load transfer.
- Jib length: 36m~108m.
- The jib luffing is realized by the front mast and rear mast. The mast is a lattice structure of welded tubes with equal section areas of insert and tapered section for two ends. The front mast is 26.5m and rear mast 25.5m.

### Hook

- Standard offers: 100t hook, 400t hook and 2000t hook.
- The 2000t hook can be decomposed into a 1000t hook, and 1000t further to a 500t hook.

### Superlift mast

- The superlift mast is a spatial lattice structure of welded tubes with equal section areas of inserts and tapered sections for two ends. The mast base and top are strengthened with steel plates, which is easier for load transfer.
- The length of the superlift mast is 50m.
- Compositions: Superlift base 9m×1, insert 12m×2, insert 8m×1, top 9m.

### Hook latch

- Each lifting hook is installed with a baffle plate to prevent wire rope from falling off.

### Configurations

- HDB: Boom + superlift mast + superlift counterweight (0 counterweight allowable).
- LJDB: Boom + luffing jib + superlift mast + superlift counterweight (0 counterweight allowable).
- HDB\_SY: Boom + super power boom + superlift mast + superlift counterweight.

Note: The equipment above are for full configuration, and the actual configuration shall be subject to the purchase order.

## Safety devices



### Monitor

- To display the parameters, such as wind speed and gradient.
- To set system parameters.

### A module

- To receive the input signals from cab and transmit to the controllers via CAN Bus.
- To send out command to controller keys, such as the alarming lights and buzzers.

### Control panel

- Fitted with components, such as select switches, electrical ignition controller, emergency switch and hand throttle.
- Main function: To send major orders for crane operation.

### RC controller

- It works as the brain to deal with all dates.

### B module

- To receive then send out controller's order to control the solenoid valve.
- To receive all input signals and transmit to the controller by CAN Bus.

### Brake of hoist mechanism

- All hoisting brakes are spring loaded normally closed disc brakes, which are featured with large braking force, maintenance-free, safe and reliable use, and long service life.

### Date recorder

- To record major parameters and dates of the crane and keep for ten years at most.

### Engine ECU

- To control the engine throttle volume and detect the data, working as the engine's brain.

### Regulation of engine power ultimate load and stalling protection

- The controller can monitor the engine power so as to prevent stalling.

### Engine monitoring dashboard

- To display the water temperature, fuel consumption, working hours, engine oil pressure, engine speed, accumulation charge, and voltage.

### Electronic level indicator

- It displays the tilting angle of the crane on the monitor in real time.

### Pharos

- It is mounted on the top of the boom/jib and alerts in air during night.

### Anemometer

- It is mounted on the top of the boom/jib to monitor the wind speed in real time and display relative data on the monitor.

### Over-hoist protection of the main and auxiliary hooks

- It is used to prevent the over-hoist of the hook to protect the boom and sheave blocks.

### Load moment indicator

- As a safe device, it is used to limit the forward tilting moment of the crane and show the data.

### Over-release protection device of the main and auxiliary hook

- When the wire rope is released to the last three wraps, the limit switch will start working, and the releasing of rope will be automatically stopped by the control system. Meanwhile, the display and the buzzer will give alarms.

### Assembly mode/work mode switch

- In assembly mode, certain safety devices are disabled to facilitate crane assembly.
- In work mode, all safety devices activate to protect the operation.

### Boom angle limiter mechanism

- When the elevation angle of the boom exceeds 88°, or jib angle exceeds 75°, corresponding limit switch will be triggered, and the control system will automatically cut off the boom hoisting. Meanwhile, the display and the buzzer will give alarm.





## Safety devices

### Back-stop device

- The boom and the superlift mast are respectively equipped with a pair of back-stop cylinders. The high pressure of the cylinder shall be overcome when the boom tilts backwards, and high pressure oil will be supplemented automatically when the boom swings forwards to increase the tension and prevent the boom vibration and shaking back.
- The jib rear mast is equipped with a pair of back-stop cylinders, while the jib front mast is equipped with a pair of pneumatic cylinders to prevent the mast from the backward inclination and tension of the jib luffing wire rope.
- The jib is also equipped with back-stop device.

### Closed circuit monitoring system

- Containing a total of 8 cameras, it can be used to monitor the winding conditions of wire ropes of each hoisting mechanism, the conditions of superlift weight, and conditions around the equipment.

### Failure auto-diagnosis system

- Failure code can help troubleshooting easily.

### Black box

- It is able to record the operation data and machine movement, and analyze the remaining running conditions and service life of machine based on the actual performance.

### Lightning protection device

- It includes the lightning protection device and the surge protection device, which can effectively protect the electric system elements and workers from lightning.

### Swing and travel visual-audio alarm

- When the machine is swinging or traveling, the horn will send out alarm per certain frequency, and warning indicator light flashes, to warn the people around the machine. This can be turned off in the control system.

### Operation release

- If operation release key pressed, all the other handles won't work, which prevents any mis-operation caused by accidental collision.

### Emergency operation system

- The independent circuit emergency operation box, connected to solenoid valve via connectors, is obtainable for crane's main operations such as load hoisting, luffing and swing.

### Remote monitoring system

- It monitors and analyzes the operation data so as to realize remote diagnosis of faults and timely solution.

### Emergency stop key

- If the crane is suddenly out of control, press the emergency stop key, the hoisting, luffing and swing and travel all brake, and the engine stop working.

### Product features in the industry

- High configuration: The major electric components are all exported from famous brand, such as Rexroth, Gessman and P+F.
- Intelligence: The CAN node adopted can enhance the self-diagnosing ability for easy maintenance.
- Energy-saving: Energy-saving technology of the engine to low down the fuel consumption and operation cost.
- High safety: The crane is equipped with LML, all limiter switch, GPS location and other safety-controlling system to ensure safe operation.

### Advantages

- 1: The data recorder will provide support for failure detection and service life analysis.
- 2: The customer's specialized demands can be met timely.
- 3: The monitoring function with recording time of 120h and more, can play back the real operation condition.
- 4: Electrical control levers are featured by shaking function during operation, so the operator can be aware of the speeds situation.
- 5: The boom area limiter promoted greatly the control safety and flexibility.
- 6: Further reach on energy saving technology will cut more cost and give better support to the regular customers in the technology upgrade.
- 7: Two SCC38000TM can be combined and work as a 4000t tonnage crawler crane (Pictured below).

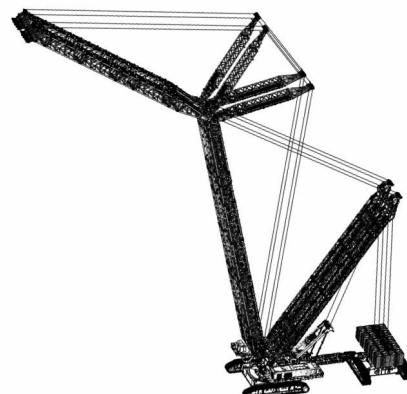



**SCC38000TM**  
**SANY CRAWLER CRANE**  
**2200 TONS LIFTING CAPACITY**

QUALITY CHANGES THE WORLD

## Technical Parameters

- Page 11 Main Performance Parameters
- Page 12 Outline Dimension
- Page 14 Transport Dimension

> 10

## Main performance parameters

Major Performance & Specification of SCC38000TM		
Performance indexes	Unit	Parameter
Maximum rated lifting capacity (HDB)	t	2200
Maximum rated lifting moment (HDB)	t·m	38000
Boom length	m	54~120
Jib length	m	36~108
Superlift mast length	m	50
Superlift mast radius	m	21~30
Maximum boom + jib	m	108+108
Longest super power boom	m	168
Maximum rope speed of single rope of main load hoist winch (outermost working layer)	m/min	121
Maximum rope speed of single rope of auxiliary load hoist winch (outermost working layer)	m/min	76.6
Maximum rope speed of single rope of boom hoist mechanism (outermost working layer)	m/min	58.3
Maximum rope speed of single rope of jib luffing mechanism (outermost working layer)	m/min	85.2
Maximum rope speed of single rope of superlift luffing mechanism (outermost working layer)	m/min	98.1
Swing speed	m/min	0~0.82 / 0~0.41
Travelling speed	Km/h	0.76
Gradeability	%	10
Maximum output power of engine	Kw	746
Maximum torque of engine	N·m	4629
Machine weight (without superlift conterweight)	t	1182 (includes basic boom,2000t hook)
Average ground bearing pressure of the crawler	Mpa	0.255 (includes basic boom,2000t hook)
Maximum transport weight of single piece	t	60
Maximum transportat dimensions of single piece (L×W×H)	m	8.4×2.5×2.7

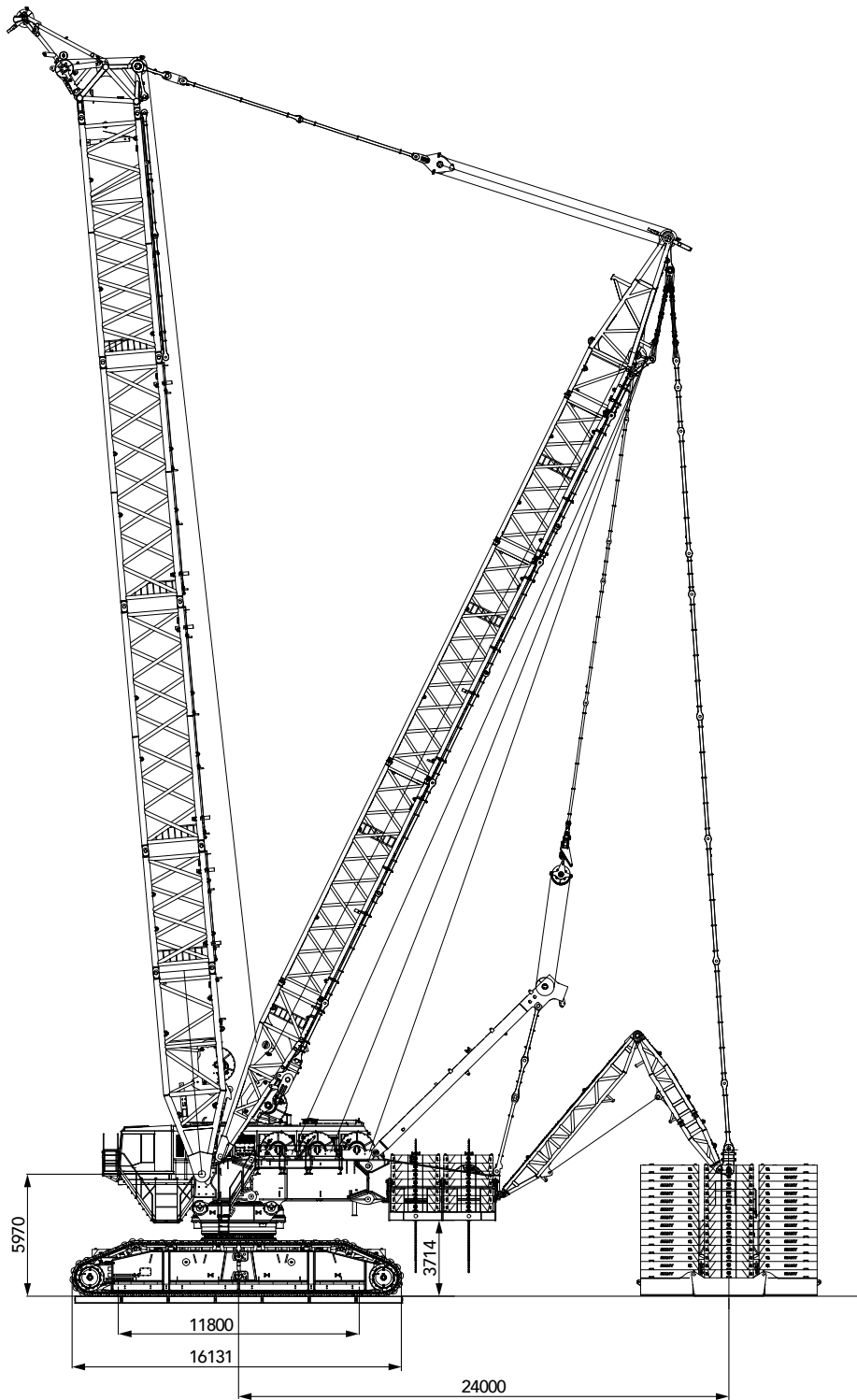
**Outline dimension**

Unit: mm

### Outline dimension

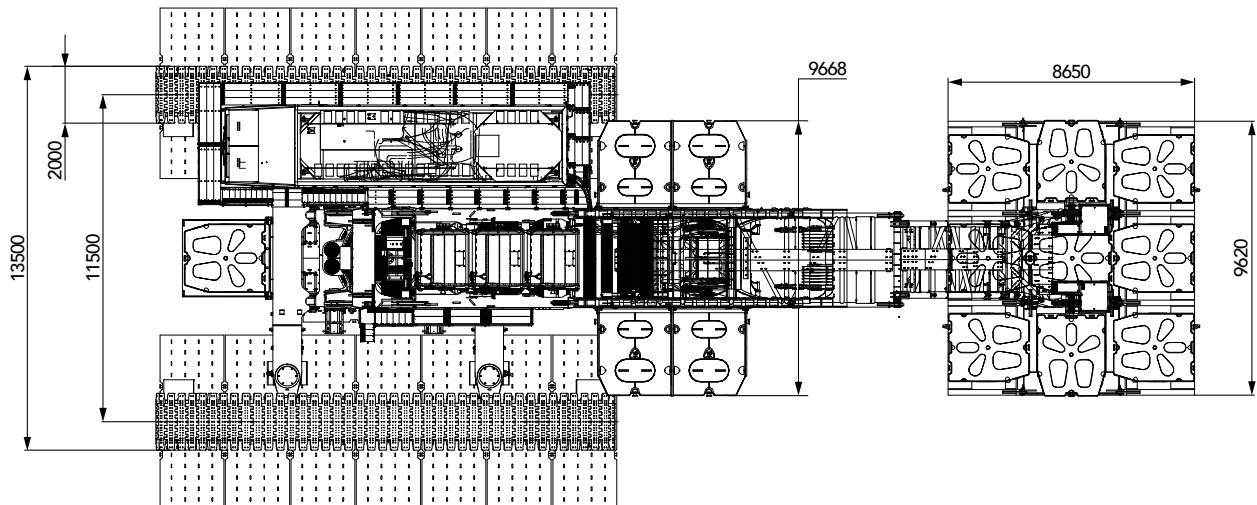

## Transport dimension

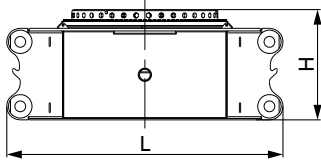

### Center swing structure (carbody+adapter) ×1

Length (L)	6.10m
Width (W)	3.65m
Height (H)	3.50m
Weight	67.0t

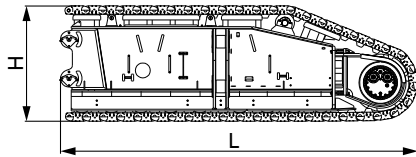

### Crawler frame I (with crawler pads) ×2

Length (L)	8.40m
Width (W)	2.50m
Height (H)	2.70m
Weight	60.0t

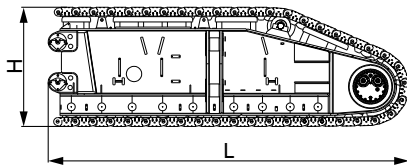

### Crawler frame II (with crawler pads) ×2

Length (L)	8.20m
Width (W)	2.50m
Height (H)	2.70m
Weight	60.0t

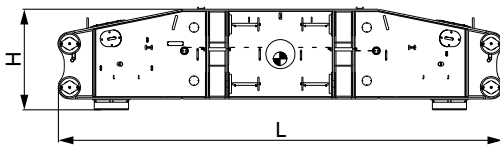

### Transverse beam (with outrigger oil cylinder) ×2

Length (L)	10.66m
Width (W)	1.90m
Height (H)	2.47m
Weight	28.1t

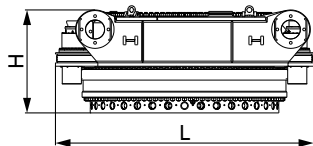

### Transition platform ×1

Length (L)	4.60m
Width (W)	3.70m
Height (H)	1.85m
Weight	52.8t

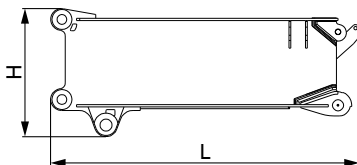

### Front rotating bed ×1

Length (L)	6.93m
Width (W)	3.75m
Height (H)	2.88m
Weight	31.9t

## Transport dimension

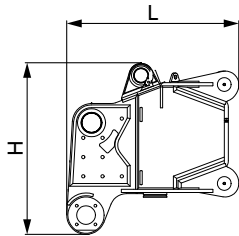

### Transverse rotating bed (single boom) ×1

Length (L)	3.13m
Width (W)	3.60m
Height (H)	3.02m
Weight	19.8t

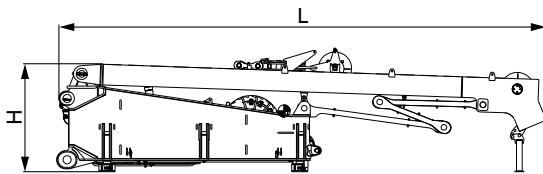

### Rear rotating bed assembly ×1

Length (L)	13.00m
Width (W)	3.72m
Height (H)	3.28m
Weight	54.1t

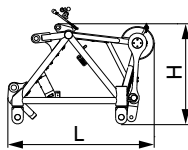

### Boom tip ×1

Length (L)	3.72m
Width (W)	4.26m
Height (H)	3.14m
Weight	15.0t

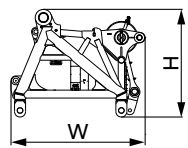

### Connection tip (for boom and jib) ×1

Length (L)	3.94m
Width (W)	3.65m
Height (H)	3.00m
Weight	12.6t

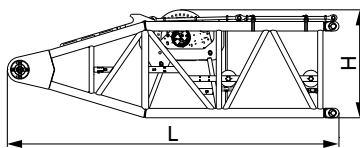

### 10m boom base (with 16.8t winch) ×1

Length (L)	10.60m
Width (W)	3.80m
Height (H)	3.50m
Weight	41.6t

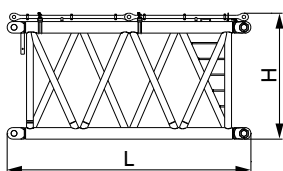

### 6m boom insert (36) ×1

Length (L)	6.40m
Width (W)	3.70m
Height (H)	3.30m
Weight	10.9t

## Transport dimension

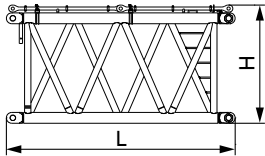

### 6m boom insert (45) ×1

Length (L)	6.40m
Width (W)	3.70m
Height (H)	3.30m
Weight	13.6t

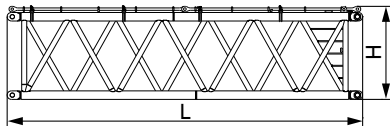

### 12m boom insert (45) ×2

Length (L)	12.40m
Width (W)	3.70m
Height (H)	3.30m
Weight	20.5t

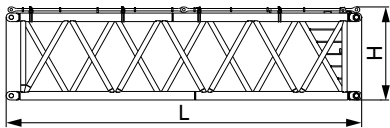

### 12m boom insert (40) ×2

Length (L)	12.40m
Width (W)	3.70m
Height (H)	3.30m
Weight	19.9t

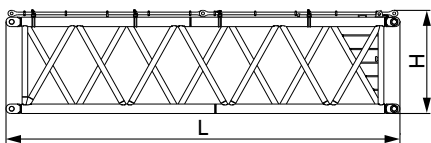

### 12m boom insert (36) ×3

Length (L)	12.40m
Width (W)	3.70m
Height (H)	3.30m
Weight	19.3t

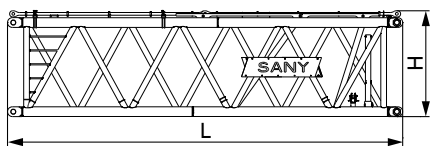

### 12m transitional section of boom ×1

Length (L)	12.40m
Width (W)	3.80m
Height (H)	3.30m
Weight	20.6t

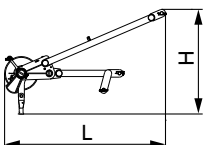

### Extension jib ×1

Length (L)	4.66m
Width (W)	2.40m
Height (H)	1.72m
Weight	1.8t



## Transport dimension

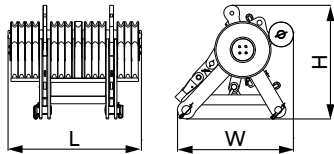

Pulley block (left/right) × 2	
Length (L)	2.17m
Width (W)	2.57m
Height (H)	1.96m
Weight	7.2t

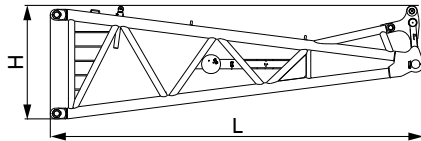

10m jib base × 1	
Length (L)	10.50m
Width (W)	3.65m
Height (H)	3.20m
Weight	13.4t

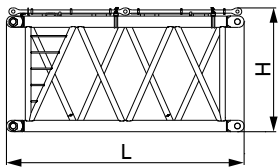

6m jib insert (30) (A/B) × 2	
Length (L)	6.40m
Width (W)	3.65m
Height (H)	3.38m
Weight	10.1t

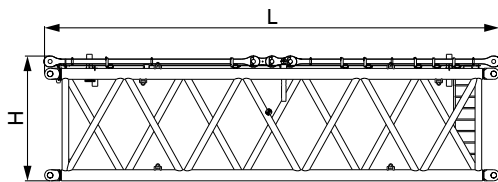

12m jib insert (30) × 1	
Length (L)	12.40m
Width (W)	3.65m
Height (H)	3.38m
Weight	17.9t

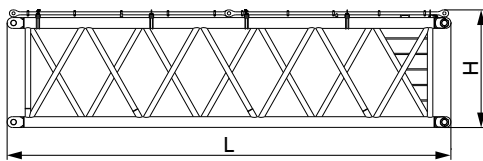

12m jib insert (20) × 2	
Length (L)	12.40m
Width (W)	3.65m
Height (H)	3.38m
Weight	13.4t

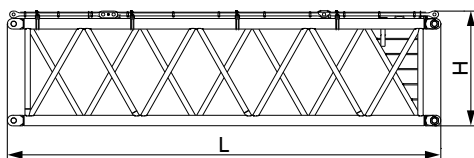

12m jib insert (17.5) (A/B) × 4	
Length (L)	12.40m
Width (W)	3.65m
Height (H)	3.38m
Weight	12.3t

## Transport dimension

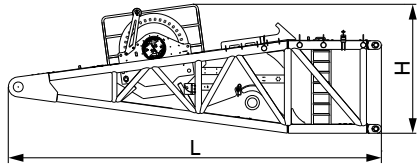

### Superlift mast base (with 20.6t winch) ×1

Length (L)	9.36m
Width (W)	3.50m
Height (H)	3.77m
Weight	39.7t

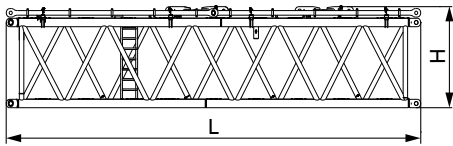

### 12m superlift mast insert (A/B) ×2

Length (L)	12.40m
Width (W)	3.50m
Height (H)	2.64m
Weight	13.8t

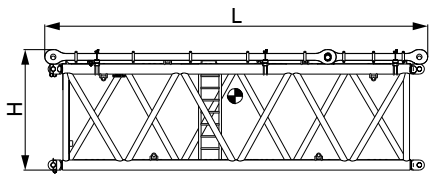

### 8m superlift mast insert ×1

Length (L)	8.40m
Width (W)	3.50m
Height (H)	2.63m
Weight	10.1t

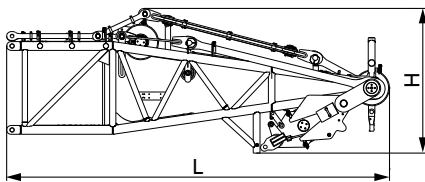

### Superlift mast top ×1

Length (L)	9.63m
Width (W)	3.50m
Height (H)	3.7m
Weight	20.0t

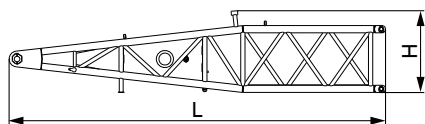

### Front mast base of luffing jib ×1

Length (L)	8.80m
Width (W)	2.88m
Height (H)	2.07m
Weight	5.1t

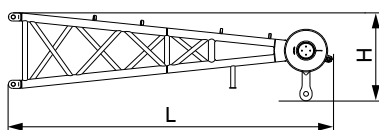

### Front mast top of luffing jib ×1

Length (L)	6.50m
Width (W)	2.78m
Height (H)	1.78m
Weight	5.4t

## Transport dimension

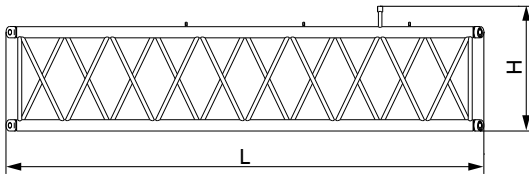

### Front mast insert of luffing jib × 1

Length (L)	12.20m
Width (W)	2.90m
Height (H)	2.09m
Weight	4.2t

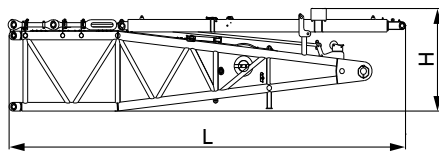

### Rear mast base of luffing jib × 1

Length (L)	8.38m
Width (W)	3.24m
Height (H)	2.20m
Weight	6.7t

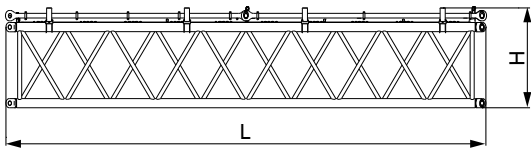

### Rear mast insert of luffing jib × 1

Length (L)	12.40m
Width (W)	3.04m
Height (H)	2.13m
Weight	7.1t

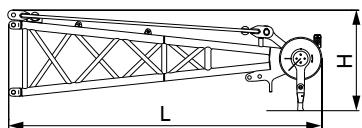

### Rear mast top of luffing jib × 1

Length (L)	6.62m
Width (W)	3.10m
Height (H)	2.14m
Weight	8.2t

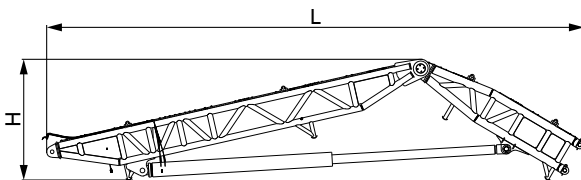

### Superlift counterweight I × 1

Length (L)	14.50m
Width (W)	3.36m
Height (H)	3.26m
Weight	14.4t

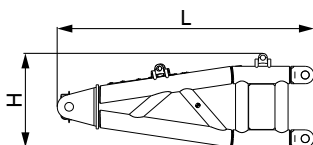

### Superlift counterweight II × 1

Length (L)	3.20m
Width (W)	3.40m
Height (H)	3.18m
Weight	2.6t

## Transport dimension

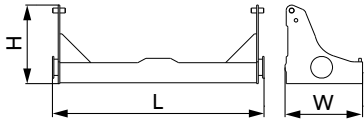

### Carbody counterweight tray

×2

Length (L)	3.80m
Width (W)	1.40m
Height (H)	1.50m
Weight	2.2t

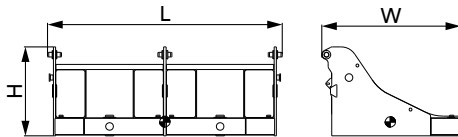

### Rear counterweight tray

×2

Length (L)	3.30m
Width (W)	5.40m
Height (H)	2.10m
Weight	30.0t

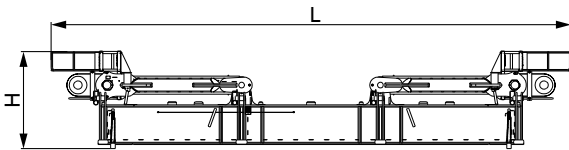

### Superlift counterweight middle tray

×1

Length (L)	11.80m
Width (W)	3.70m
Height (H)	2.10m
Weight	30.0t

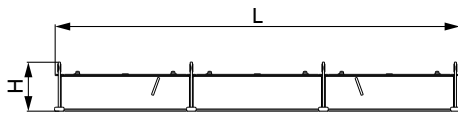

### Superlift counterweight side tray

×2

Length (L)	9.65m
Width (W)	2.94m
Height (H)	1.17m
Weight	16.8t

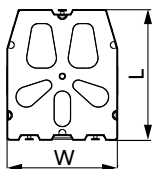

### 10t counterweight block

×146

Length (L)	2.85m
Width (W)	2.40m
Height (H)	0.45m
Weight	10.0t

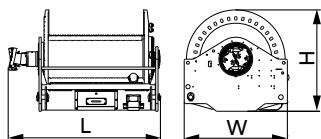

### Main load hoist mechanism

×2

Length (L)	2.70m
Width (W)	1.80m
Height (H)	1.80m
Weight	21.2t

## Transport dimension

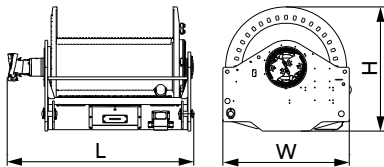

### Aux. load hoist mechanism ×1

Length (L)	2.70m
Width (W)	1.80m
Height (H)	1.80m
Weight	15.1t

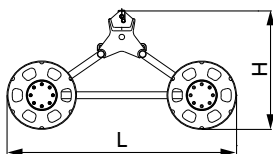

### Trolley ×1

Length (L)	3.30m
Width (W)	2.65m
Height (H)	1.80m
Weight	2.4t

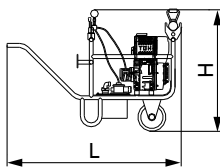

### Portable power pack ×1

Length (L)	1.60m
Width (W)	0.66m
Height (H)	1.10m
Weight	0.22t

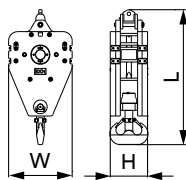

### 100t hook ×1

Length (L)	2.90m
Width (W)	1.40m
Height (H)	0.82m
Weight	8.0t

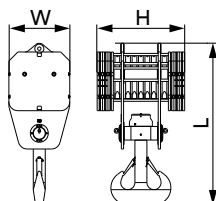

### 400t hook ×1

Length (L)	3.58m
Width (W)	1.35m
Height (H)	1.94m
Weight	16.2t

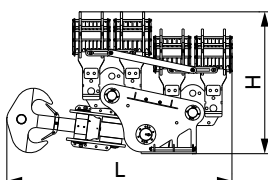

### 2000t hook ×1

Length (L)	6.50m
Width (W)	1.80m
Height (H)	4.20m
Weight	49.3t

## Transport dimension

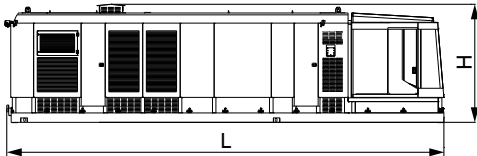

### Power container (with cab) ×1

Length (L)	12.20m
Width (W)	3.50m
Height (H)	3.20m
Weight	29.5t

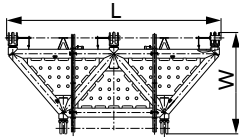

### Lower transitional section of SY4A superlift power boom ×1

Length (L)	7.11m
Width (W)	3.40m
Height (H)	3.30m
Weight	14.1t

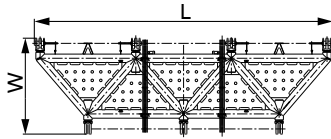

### Lower transitional section of SY4B superlift power boom ×1

Length (L)	10.46m
Width (W)	3.40m
Height (H)	3.30m
Weight	17.4t

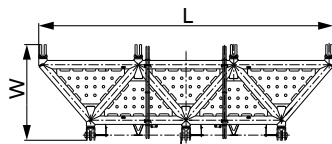

### Upper transitional section of SY4C superlift power boom ×1

Length (L)	10.35m
Width (W)	3.40m
Height (H)	3.30m
Weight	17.0t

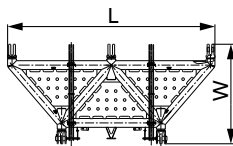

### Upper transitional section of SY4D superlift power boom ×1

Length (L)	7.00m
Width (W)	3.40m
Height (H)	3.30m
Weight	11.7t

#### Note:

- 1.The transport dimensions of each part are schematic, may not be proportional to the real parts. The dimensions are designed value without package considered.
- 2.The weight is designed value that the actual manufactured part may deviate slightly.
- 3.The dimensions and weight of each part may upgrade along the time. The final values are subject to the new product.



**SCC38000TM**  
**SANY CRAWLER CRANE**  
**2200 TONS LIFTING CAPACITY**

QUALITY CHANGES THE WORLD

## Configurations

- Page 24 Boom Combination
- Page 26 HDB Configuration
- Page 29 LJDB Configuration
- Page 35 HDB\_SY Configuration
- Page 38 FJDB\_7 Configuration
- Page 40 LJDB\_SY Configuration
- Page 42 FJhDB Configuration



## Combination



HDB  
(54m~120m)  
Boom with superlift

LJDB  
(Boom 54m~108m, jib 36m~108m)  
Luffing jib with superlift

HDB\_SY  
(78m~168m)  
Luffing jib with superlift

Configuration	Boom combination	Boom length
HDB	Boom + superlift mast + superlift counterweight	54m~120m
LJDB	Boom + luffing jib + superlift mast+ superlift counterweight	( 54m~108m ) + ( 36m~108m )
HDB_SY	Boom + super power boom + superlift mast + superlift counterweight	78m~168m

Note: The above is only the schematic diagram of working conditions.



**Combination**

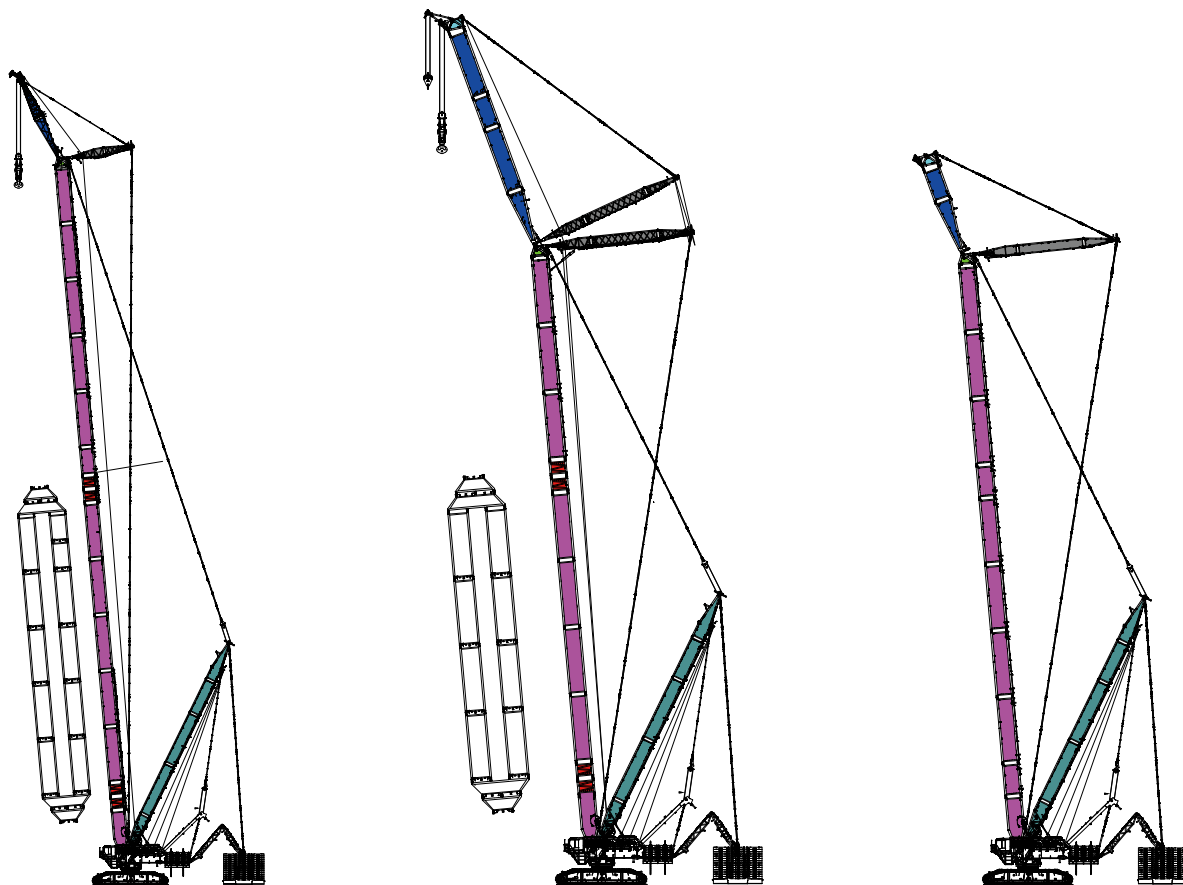

FJDB\_7  
(Boom 126~150m, jib 18m)  
Light fixed jib with superlift

LJDB\_SY  
(Boom 66~108m, jib 36~96m)  
Luffing jib with superlift

FJhDB  
(Boom 78~120m, jib 18m)  
Fixed jib with superlift

Configuration	Boom combination	Boom length
FJDB_7	Boom + power boom + fixed jib + superlift mast + superlift counterweight	(126m~150m) +18m
LJDB_SY	Boom + power boom + luffing jib + superlift mast + superlift counterweight	(66~108m)+(36~96m)
FJhDB	Boom + fixed jib + superlift mast + superlift counterweight	(78m~120m) +18m

## Boom combination in HDB

### Boom combination in HDB configuration

Boom length(m)	Boom insert	
	6m	12m
54	1	2
60	0	3
66	1	3
72	2	3
78	1	4
84	2	4
90	1	5
96	2	5
102	1	6
108	2	6
114	1	7
120	2	7

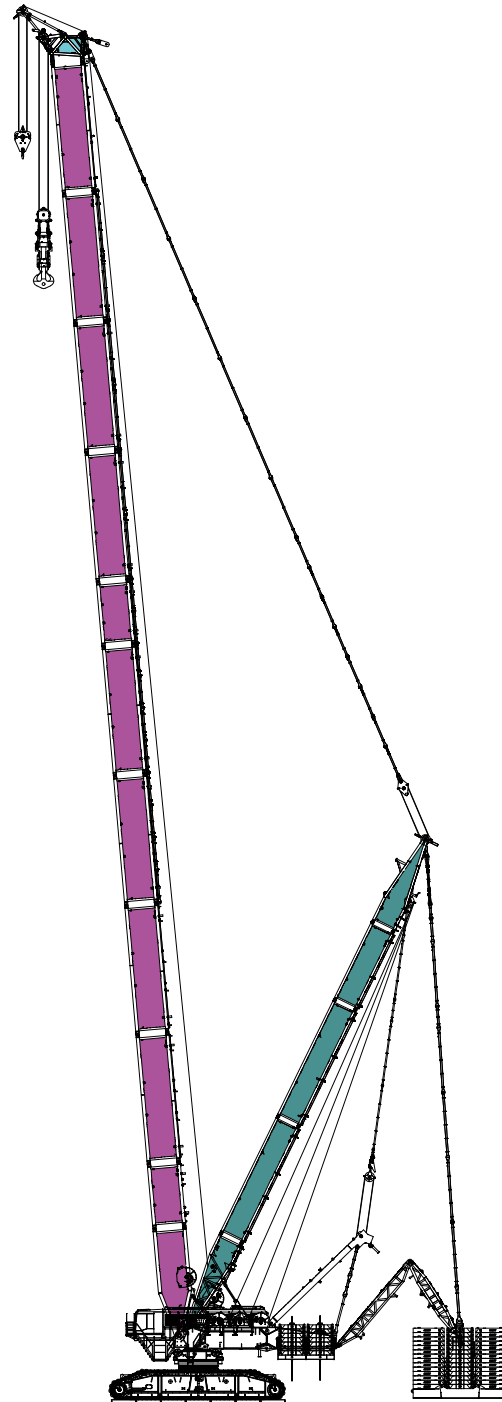

HDB  
(54m~120m)

## Working range of HDB

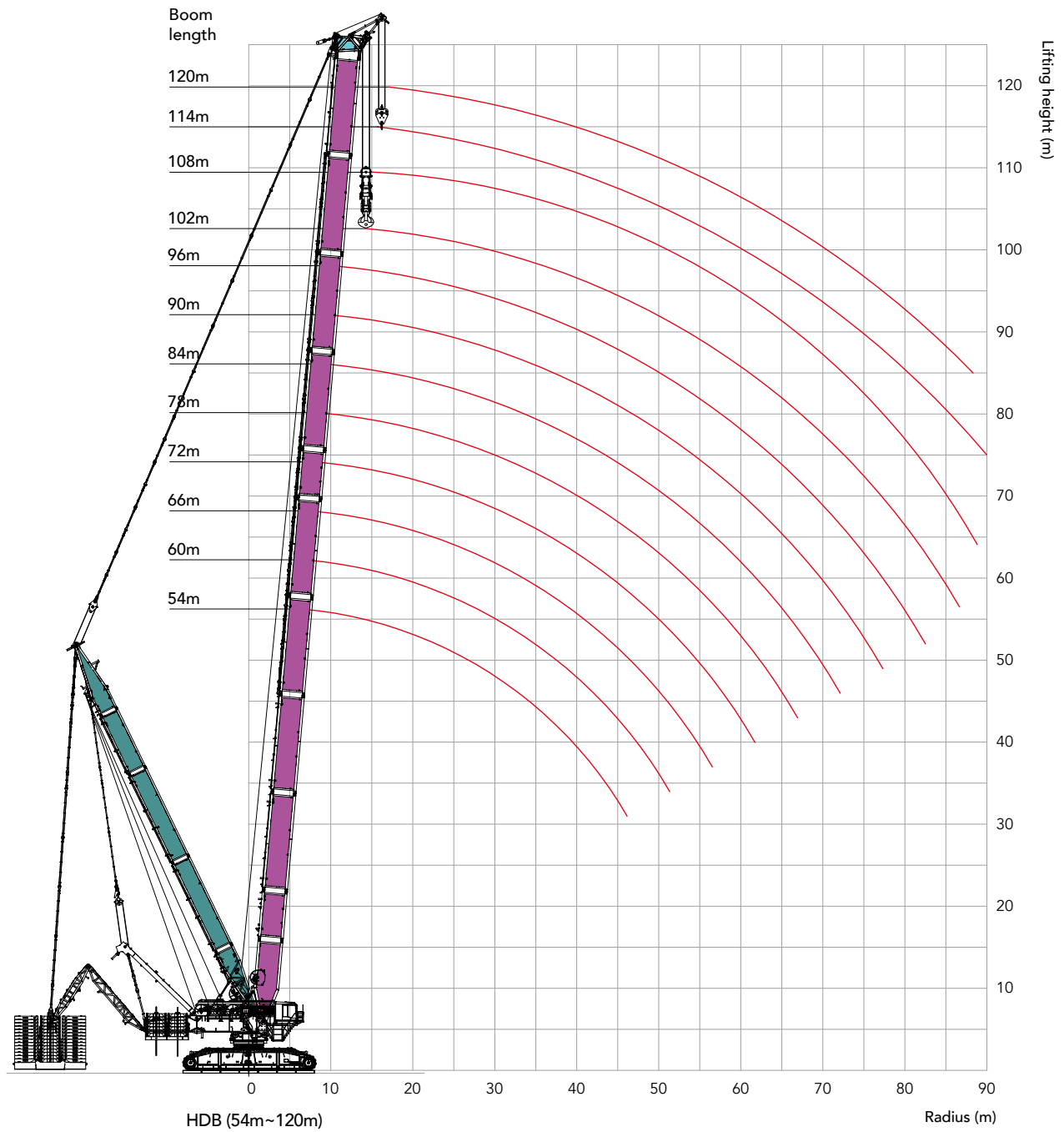

## Load chart of HDB configuration

HDB configuration													
Superlift radius 30m, superlift CW 1160t, rear CW 340t, carbody CW 89t													
Radius (m)	Boom length (m)												Radius (m)
	54	60	66	72	78	84	90	96	102	108	114	120	
9	2200												9
10	2200	1966	1878										10
11	2200	1977	1876	1631	1406								11
12	2200	1986	1885	1639	1408	1222	1067						12
13	2200	1992	1891	1644	1413	1226	1071	931	826				13
14	2200	1998	1897	1650	1418	1230	1074	934	826	728	644		14
15	2200	2008	1907	1653	1425	1233	1077	936	827	729	645	575	15
16	2200	2018	1916	1656	1433	1235	1079	938	829	731	647	576	16
17	2157	2025	1929	1663	1435	1237	1081	942	830	732	649	576	17
18	2112	1978	1943	1669	1436	1238	1082	946	831	733	652	577	18
19	1885	1855	1866	1674	1441	1243	1086	947	832	733	652	579	19
20	1770	1745	1759	1679	1446	1247	1090	948	832	733	653	581	20
22	1574	1556	1575	1565	1453	1247	1090	953	837	738	653	580	22
24	1413	1472	1423	1491	1398	1252	1095	952	841	737	656	583	24
26	1277	1335	1295	1362	1281	1254	1099	956	840	741	659	582	26
28	1224	1218	1246	1252	1241	1159	1102	959	845	743	657	584	28
30	1119	1117	1147	1156	1149	1075	1053	962	842	745	659	586	30
32	1027	1084	1059	1071	1068	1055	983	960	844	743	660	587	32
34	999	1002	982	997	997	986	921	901	845	744	661	588	34
36	922	928	913	981	933	925	912	848	828	745	662	585	36
38	853	862	898	918	875	870	859	800	782	745	662	587	38
40	789	849	839	861	869	820	812	798	741	722	663	587	40
44	719	738	736	760	772	774	728	718	706	653	637	586	44
48	653	682	686	716	690	696	657	651	641	628	581	566	48
52		591	604	637	654	628	630	592	585	574	563	519	52
56			565	604	590	596	573	573	536	527	518	506	56
60			526	557	553	546	546	524	522	486	478	468	60
64				507	507	508	505	480	481	476	442	434	64
68					476	472	462	466	443	440	436	403	68
72						440	437	430	431	407	405	399	72
76							408	405	401	398	376	372	76
80								382	379	369	372	369	80
84									356	353	344	346	84
88										332	328	322	88
92											308	305	92
96												290	96
100													100
104													104

## Boom combination in LJDB

Boom combination in LJDB configuration		
Boom length(m)	Jib insert	
	6m	12m
36	2	1
42	1	2
48	2	2
54	1	3
60	2	3
66	1	4
72	2	4
78	1	5
84	2	5
90	1	6
96	2	6
102	1	7
108	2	7

Note: See HDB configuration for boom length

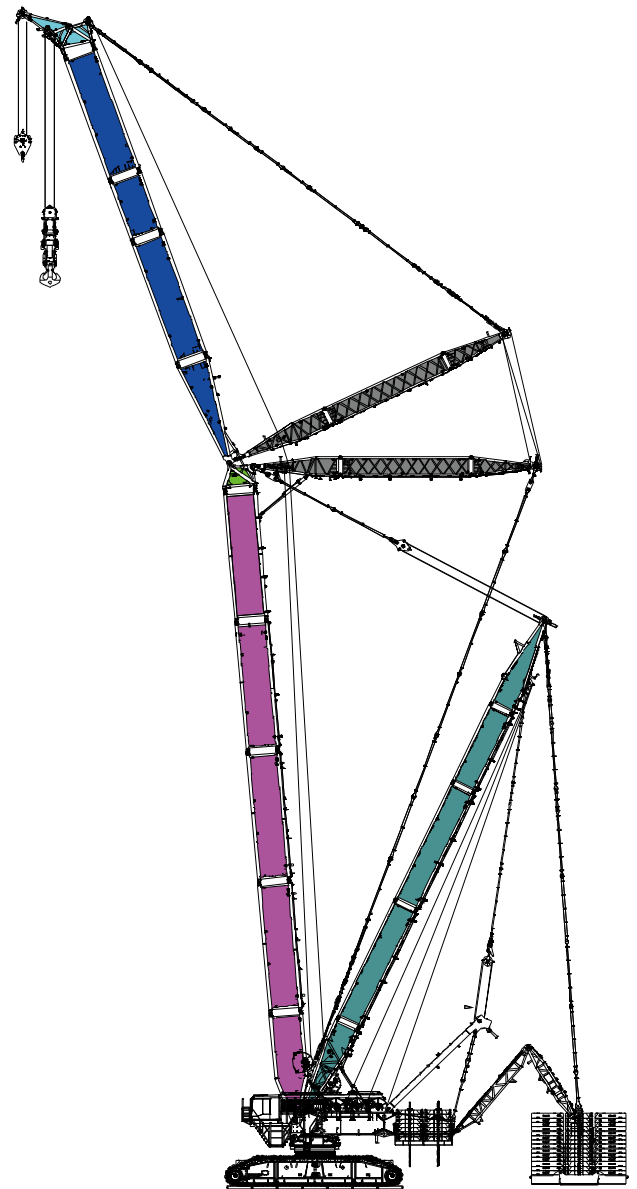

LJDB  
(54m~108m)+(36m~108m)

**Working range of LJDB**

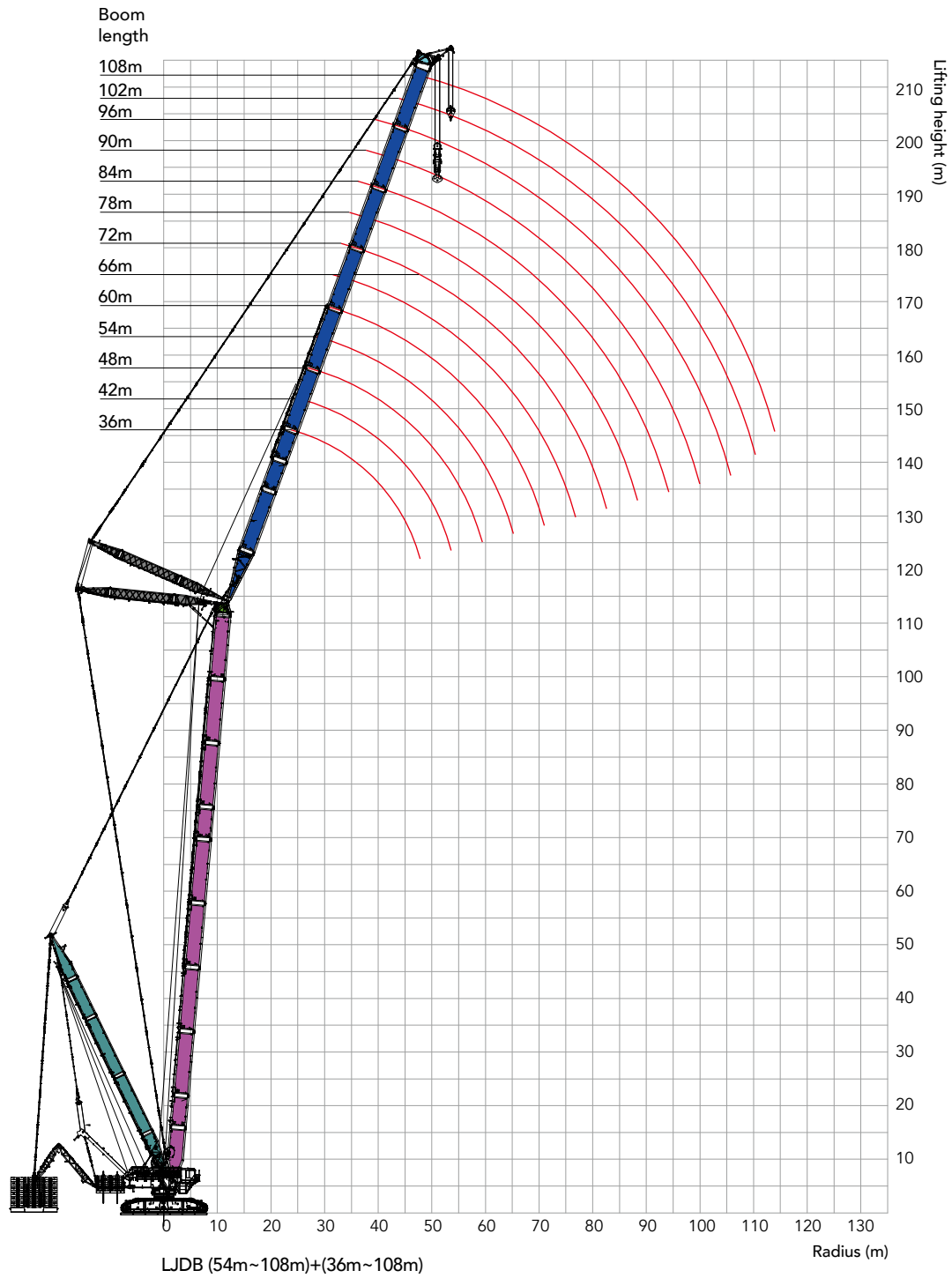

Unit: t

## Load chart of LJDB configuration

LJDB configuration (boom length 66m)														
Boom angle 85°, superlift radius 30m, superlift CW 1160t, rear CW 340t, carbody CW 89t														
Radius (m)	Jib length (m)													Radius (m)
	36	42	48	54	60	66	72	78	84	90	96	102	108	
20	839													20
22	825	734												22
24	803	723	643											24
26	754	707	635	563										26
28	704	669	626	558	497	437								28
30	659	628	595	551	493	435	388							30
32	616	590	561	529	488	432	386	339						32
34	574	553	530	506	475	428	384	338	301	260				34
36	533	517	502	480	456	424	382	336	300	260	231			36
38	495	485	471	454	433	408	378	334	299	259	230	196		38
40	462	452	442	431	414	392	373	332	297	258	230	196	173	40
44		394	391	383	372	357	344	325	293	255	228	194	172	44
48		346	343	341	334	324	313	297	285	252	225	192	170	48
52			304	301	298	292	285	274	266	248	221	190	168	52
56				268	266	263	259	250	245	231	218	187	165	56
60				237	237	236	233	228	224	214	204	184	162	60
64					213	213	211	209	205	196	190	181	159	64
68						191	189	190	186	182	175	169	156	68
72						171	171	171	169	167	162	157	151	72
76							154	155	154	153	148	145	139	76
80								140	140	139	136	134	129	80
84								126	127	128	126	123	120	84
88									116	116	116	113	111	88
92										106	105	104	102	92
96											96.8	95.9	94.9	96
100											89.0	87.9	86.4	100
104												79.9	79.4	104
108													72.7	108
112													66.8	112

## Load chart of LJDB configuration

LJDB configuration (boom length 78m)														
Boom angle 85°, superlift radius 30m, superlift CW 1160t, rear CW 340t, carbody CW 89t														
Radius (m)	Jib length (m)													Radius (m)
	36	42	48	54	60	66	72	78	84	90	96	102	108	
22	652													22
24	639	576	517											24
26	623	566	510	457										26
28	594	554	503	452	405									28
30	557	532	493	447	401	357								30
32	522	501	476	440	397	355	319	282						32
34	487	471	450	428	391	351	316	281	250					34
36	455	441	424	406	385	348	314	279	250	218				36
38	424	414	401	386	367	344	311	277	248	217	193	166		38
40	397	387	377	364	350	333	307	275	247	216	192	165	145	40
44	347	340	332	327	314	303	291	269	243	214	191	164	144	44
48		298	293	291	282	275	266	256	238	210	188	162	143	48
52			260	258	253	248	242	235	225	206	185	160	141	52
56			229	229	226	224	218	212	206	196	181	158	139	56
60				204	203	201	197	193	189	181	172	154	136	60
64					181	181	177	176	171	166	159	151	134	64
68					163	162	160	159	157	153	147	142	131	68
72						145	144	143	142	139	135	131	125	72
76							130	130	128	127	124	121	116	76
80								117	117	115	113	110	107	80
84									105	105	104	101	99.2	84
88										95.9	94.3	93.0	91.2	88
92											87.4	86.6	85.3	92
96												79.9	79.1	96
100													77.8	100
104														104
108														108
112														112



Unit: t

## Load chart of LJDB configuration

LJDB configuration (boom length 96m)														
Boom angle 85°, superlift radius 30m, superlift CW 1160t, rear CW 340t, carbody CW 89t														
Radius (m)	Jib length (m)													Radius (m)
	36	42	48	54	60	66	72	78	84	90	96	102	108	
24	447	407												24
26	437	400	361											26
28	426	392	355	322										28
30	414	382	348	317	286									30
32	402	373	341	312	282	255	228							32
34	386	363	333	306	278	252	226	202						34
36	361	347	325	300	273	249	224	201	179					36
38	339	328	315	293	268	245	221	199	178	156	138			38
40	319	309	297	286	263	241	218	197	176	155	137	118		40
44	279	272	265	256	247	232	211	191	172	153	135	117	102	44
48		241	235	230	222	215	203	185	167	150	132	115	100	48
52		214	209	205	199	195	188	179	162	146	130	113	98.9	52
56			185	183	179	176	171	167	156	141	126	110	96.7	56
60				163	160	158	154	152	146	136	122	107	94.1	60
64					143	142	139	137	133	128	118	104	91.2	64
68					129	127	124	124	120	116	111	100	88.4	68
72						114	112	111	108	106	101	97.4	85.2	72
76							101	100	98.4	97.0	92.8	91.2	81.9	76
80							91.2	91.0	89.0	87.9	84.4	82.5	78.7	80
84								81.6	79.9	79.6	76.7	75.5	72.5	84
88									72.8	71.6	69.2	68.6	65.4	88
92									65.3	64.8	63.2	62.0	59.4	92
96										58.6	56.8	56.0	53.8	96
100											51.6	50.3	48.3	100
104											46.1	45.0	43.4	104
108												40.8	39.4	108
112													35.0	112

## Load chart of LJDB configuration

LJDB configuration (boom length 108m)														
Boom angle 85°, superlift radius 30m, superlift CW 1160t, rear CW 340t, carbody CW 89t														
Radius (m)	Jib length (m)													Radius (m)
	36	42	48	54	60	66	72	78	84	90	96	102	108	
24	353													24
26	345	315												26
28	336	309	279											28
30	327	302	274	250	224									30
32	317	294	268	246	221	201								32
34	308	286	262	241	218	198	176							34
36	298	278	255	236	214	195	174	156	138					36
38	290	270	249	231	209	192	171	155	137	120				38
40	277	262	242	225	205	188	169	153	135	120	104			40
44	246	238	228	214	195	181	163	148	131	117	102	88.1	74.7	44
48		211	204	198	185	172	156	142	127	114	99.7	86.2	73.3	48
52		188	182	178	172	164	149	136	122	110	96.5	84.1	71.6	52
56			163	159	154	150	142	131	117	105	93.2	81.4	69.3	56
60				143	138	136	131	125	112	101	89.4	78.3	66.7	60
64				128	124	122	118	117	107	97.2	85.4	75.2	64.1	64
68					112	110	106	105	101	92.5	81.5	71.8	61.1	68
72						99.3	96.0	95.3	91.9	88.1	77.4	68.3	58.1	72
76						89.7	86.4	86.0	83.1	80.5	73.5	64.9	55.1	76
80							77.9	77.4	75.1	72.9	69.5	61.5	51.9	80
84								69.3	67.5	65.7	63.2	58.0	48.8	84
88								62.8	60.7	59.2	57.0	54.7	45.8	88
92									54.4	53.0	51.0	50.1	42.8	92
96										48.2	45.7	44.9	39.8	96
100											41.3	40.1	37.0	100
104											36.8	35.7	33.6	104
108												31.7	29.7	108
112													26.1	112
116													22.9	116

## Boom combination in HDB\_SY

Boom combination in HDB_SY configuration			
Boom length(m)	Power boom insert	Boom insert	
	12m	6m	12m
78	4	1	-
84	5	-	-
90	5	1	-
96	6	-	-
102	6	1	-
108	6	-	1
114	6	1	1
120	6	-	2
126	6	1	2
132	6	2	2
138	6	1	3
144	6	2	3
150	6	1	4
156	6	2	4
162	6	1	5
168	6	2	5

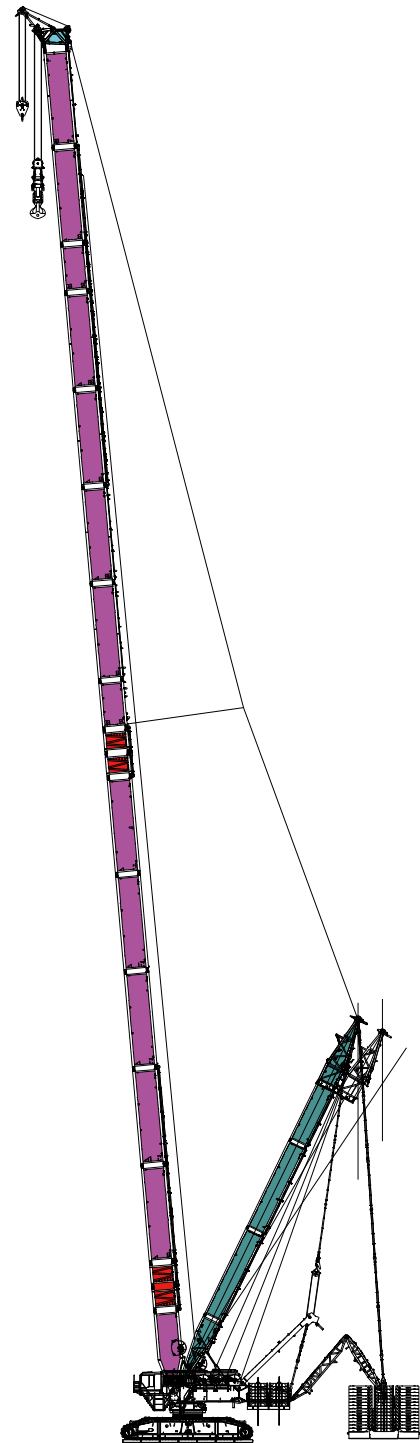

HDB\_SY  
(78m~168m)

## Working range of HDB\_SY

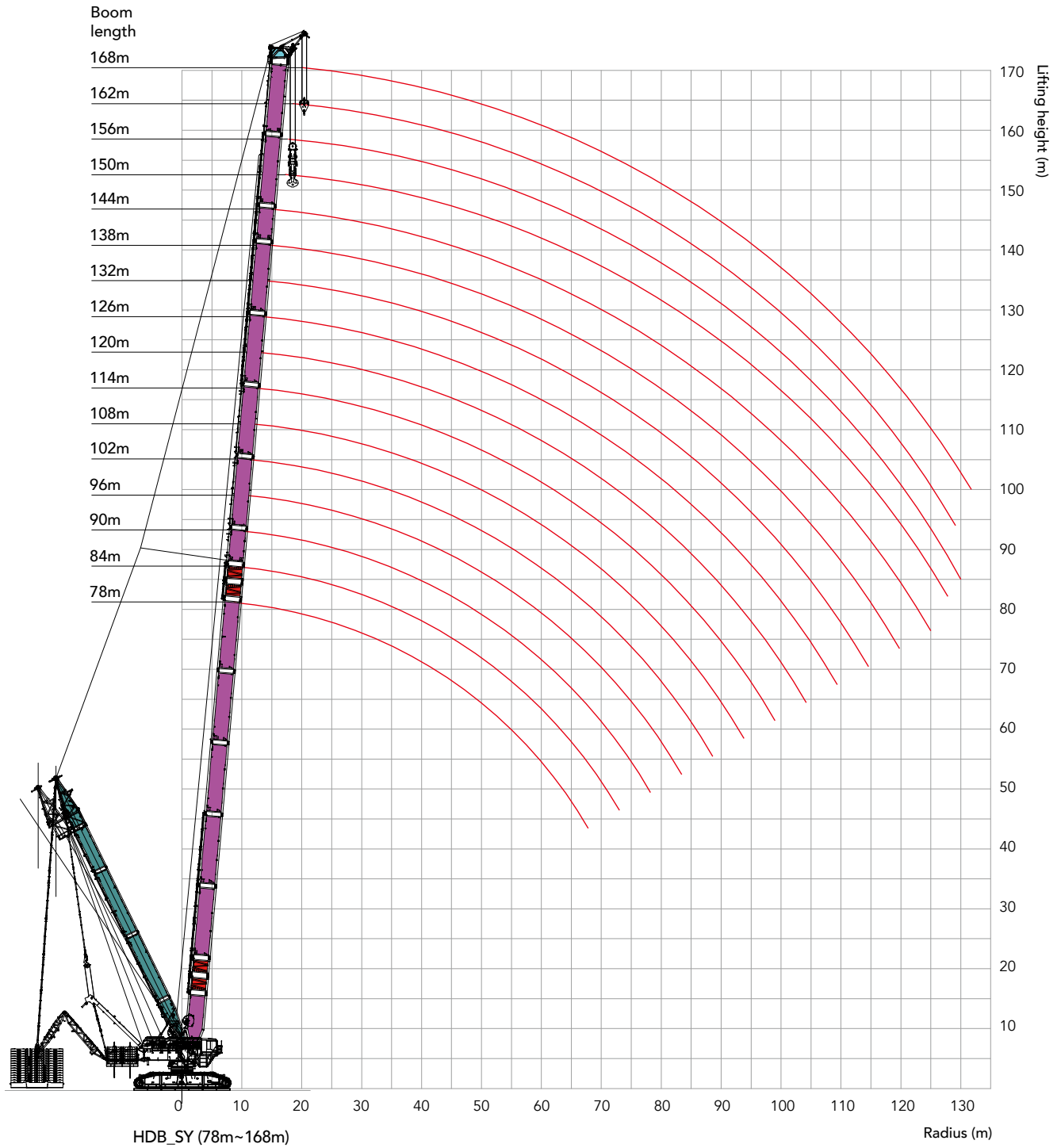

Unit: t

## Load chart of HDB\_SY configuration

HDB_SY configuration																	
Superlift radius 30m, superlift CW 1160t, rear CW 340t, carbody CW 89t																	
Radius (m)	Boom length(m)															Radius (m)	
	78	84	90	96	102	108	114	120	126	132	138	144	150	156	162		168
11	1376																11
12	1376	1376	1376														12
13	1376	1376	1376	1376	1376												13
14	1376	1376	1376	1376	1376	1289	1205										14
15	1376	1376	1376	1376	1368	1287	1205	1134	1002								15
16	1376	1376	1376	1376	1360	1285	1202	1130	1002	949	858						16
17	1376	1376	1376	1376	1352	1276	1195	1119	987	951	862	776	709				17
18	1376	1376	1376	1376	1344	1267	1189	1102	971	952	866	777	709	640	579		18
19	1376	1376	1376	1376	1338	1259	1183	1087	956	953	867	780	709	639	579	523	19
20	1376	1376	1376	1376	1331	1251	1177	1071	942	954	867	778	709	639	578	524	20
22	1376	1376	1376	1310	1268	1230	1168	1043	916	961	846	754	712	642	580	525	22
24	1376	1364	1298	1256	1158	1124	1089	1017	892	943	825	729	711	644	582	523	24
26	1278	1249	1192	1155	1120	1034	1002	973	869	913	797	704	701	631	577	524	26
28	1235	1151	1101	1067	1036	1007	928	901	848	849	769	684	679	610	555	507	28
30	1141	1066	1021	992	964	938	863	839	814	790	746	658	656	590	536	490	30
32	1058	1043	952	925	900	876	850	784	760	738	718	637	637	569	517	473	32
34	985	973	890	866	844	822	798	776	713	693	673	616	613	551	498	453	34
36	919	910	880	813	793	774	751	731	709	652	634	595	594	530	482	439	36
38	860	854	828	765	747	730	709	690	670	650	598	573	564	513	463	421	38
40	852	802	780	763	706	690	671	653	634	616	566	549	534	495	447	407	40
44	754	754	696	683	671	621	604	589	572	555	540	522	480	464	419	379	44
48	669	674	625	616	606	596	548	534	519	504	490	476	462	433	391	354	48
52	632	604	598	557	550	542	530	487	474	460	448	434	422	409	366	331	52
56	566	572	541	537	500	495	485	475	434	422	411	398	387	374	345	312	56
60	529	519	516	489	487	453	445	436	426	388	378	367	356	344	327	293	60
64	480	482	474	445	445	444	409	402	393	383	373	338	328	317	308	277	64
68	450	445	430	433	407	408	403	371	363	354	346	336	304	293	285	262	68
72		412	407	395	398	375	371	367	329	328	321	311	303	272	264	249	72
76			376	372	366	368	342	340	289	304	297	289	281	272	244	235	76
80			352	346	333	340	338	314	257	304	276	269	262	253	246	218	80
84				323	320	311	313	286	221	282	278	250	243	235	229	215	84
88					296	297	288	252	192	262	258	252	226	219	213	205	88
92						278	274	219	164	243	240	235	210	203	198	191	92
96						260	253	186	138	245	222	218	214	189	184	177	96
100							220	160	107	227	226	202	199	193	171	164	100
104								130	83.6	209	209	187	184	179	175	152	104
108									60.8	201	193	191	171	166	163	157	108
112									38.1	188	177	176	175	154	151	146	112
116										176	174	162	162	159	139	135	116
120											162	159	148	146	145	124	120
124												148	145	134	133	114	124
128													134	122	122	107	128
132													124	121	111	98.6	132
136														111	108	89.4	136
140															97.4	76.8	140
144																71.1	144
148																60	148

# Working range of FJDB\_7

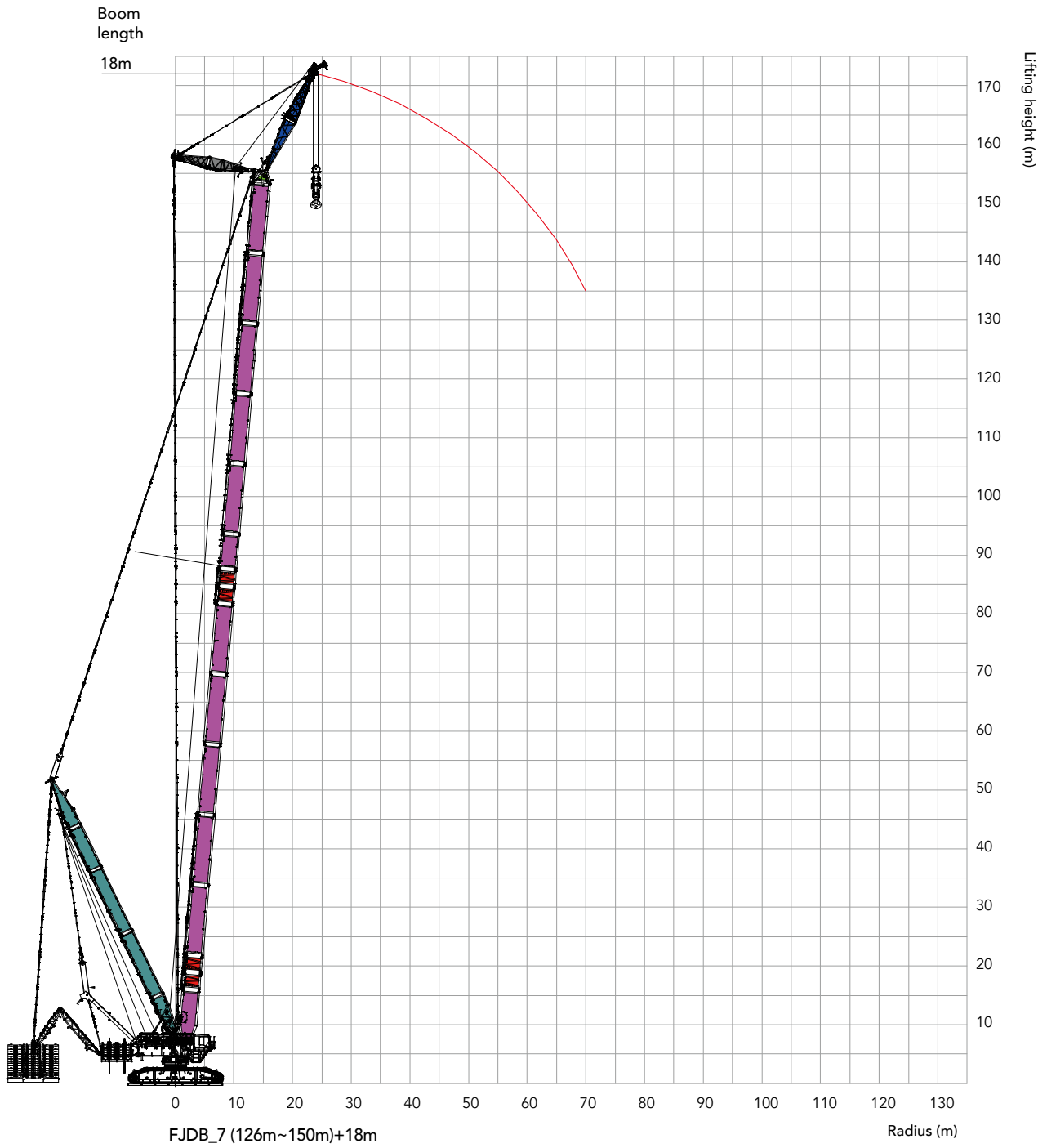

Unit: t

### Load chart of FJDB\_7 configuration

FJDB_7 configuration						
Superlift radius 30m, superlift CW 1160t, rear CW 340t, carbody CW 89t						
Radius (m)	Boom length(m)					Radius (m)
	126	132	138	144	150	
24	400					24
26	400	400	400	400		26
28	400	400	400	400	400	28
30	400	400	400	400	400	30
32	400	400	400	400	400	32
34	400	400	400	400	400	34
36	400	400	400	400	400	36
38	400	400	400	400	400	38
40	400	400	400	400	400	40
44	400	400	400	400	400	44
48	400	400	400	400	400	48
52	400	400	400	400	384	52
56	400	400	400	393	361	56
60	397	385	374	361	342	60
64	367	356	345	334	323	64
68	340	329	320	309	299	68
72	337	306	297	287	277	72
76	314	305	296	266	257	76
80	292	284	276	267	239	80
84	271	264	257	249	241	84
88	253	246	240	232	224	88
92	254	229	223	216	209	92
96	237	232	208	201	195	96
100	220	216	211	187	181	100
104	204	200	197	191	168	104
108	207	186	183	178	173	108
112	191	190	169	165	161	112
116	176	175	174	153	149	116
120	172	162	161	141	138	120
124	161	148	148	145	127	124
128	148	147	135	134	132	128
132	140	137	134	122	121	132
136	131	128	125	122	110	136
140	120	119	113	113	100	140
144	93.0	110	108	103	101	144
148		93.2	99.9	96.7	93.4	148
152			90.2	88.9	82.1	152
156			65.8	81.4	79.0	156
160				65.4	71.6	160
164					62.3	164

# Working range of LJDB\_SY

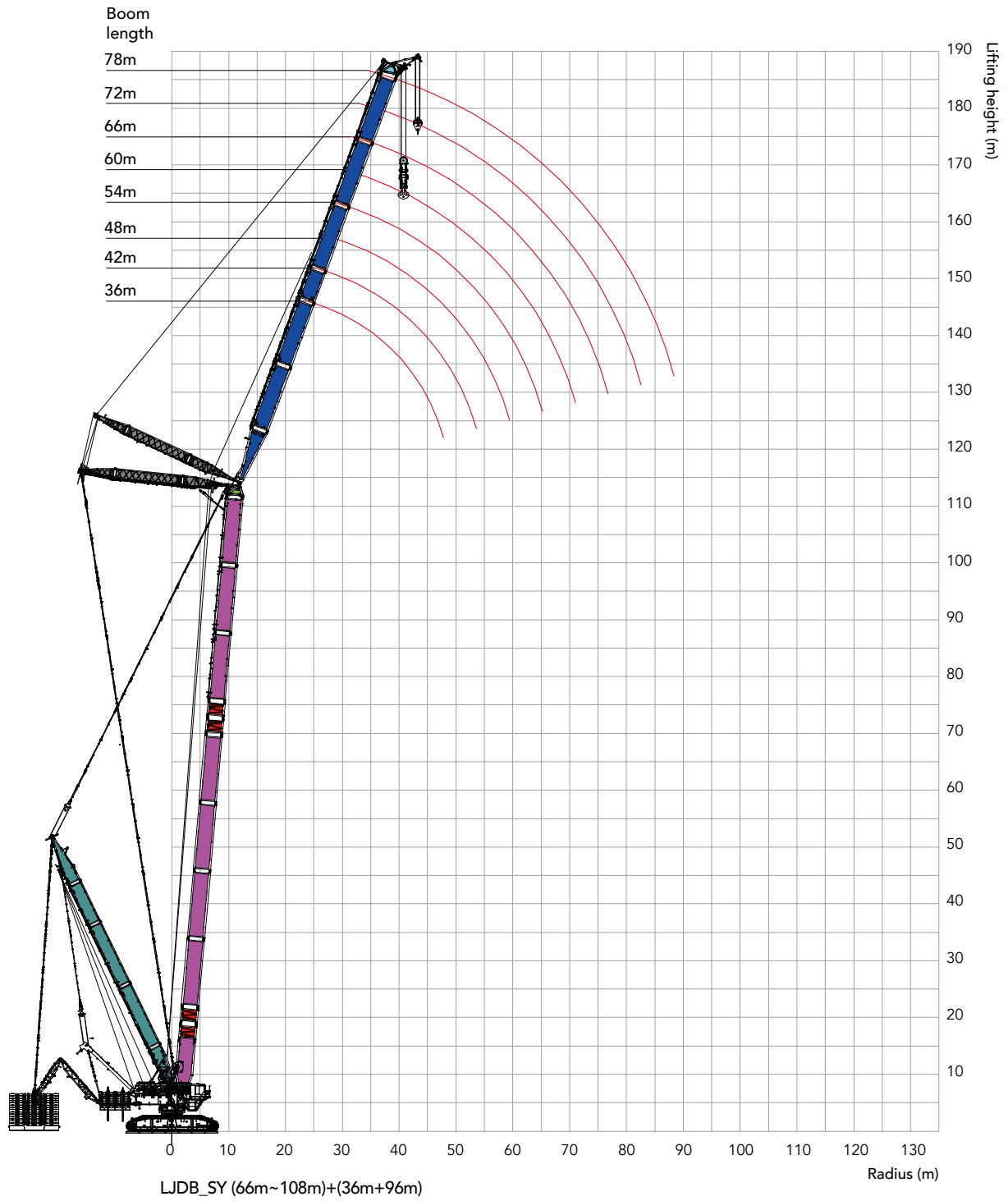



Unit: t

### Load chart of LJDB\_SY configuration

LJDB_SY configuration												
Boom length 66m, superlift radius 30m, superlift CW 1160t, rear CW 340t, carbody CW 89t												
Radius (m)	Boom length (m)										Radius (m)	
	36	42	48	54	60	66	72	78	84	90		96
20	917											20
22	917	860										22
24	898	851	803									24
26	865	823	777	733	682							26
28	831	792	754	712	676	597						28
30	795	765	729	692	658	595	532					30
32	754	732	707	672	638	592	530	471				32
34	718	698	680	650	620	585	528	470	421	373		34
36	677	664	647	628	602	570	525	468	420	372	332	36
38	621	630	619	601	580	555	521	466	418	371	332	38
40	575	585	586	573	557	542	516	463	416	370	331	40
44		510	509	523	510	488	483	453	412	366	328	44
48		438	461	451	460	441	441	420	405	361	324	48
52			412	416	402	401	401	385	371	353	320	52
56				356	372	359	356	351	342	329	314	56
60				316	326	316	314	318	314	304	291	60
64					297	298	296	282	284	280	269	64
68						259	263	266	254	255	249	68
72						234	230	240	239	228	229	72
76							211	211	218	215	205	76
80								197	193	196	183	80
84								164	178	175	178	84
88									155	154	159	88
92										144	140	92
96											133	96
100											112	100

# Working range of FJhDB

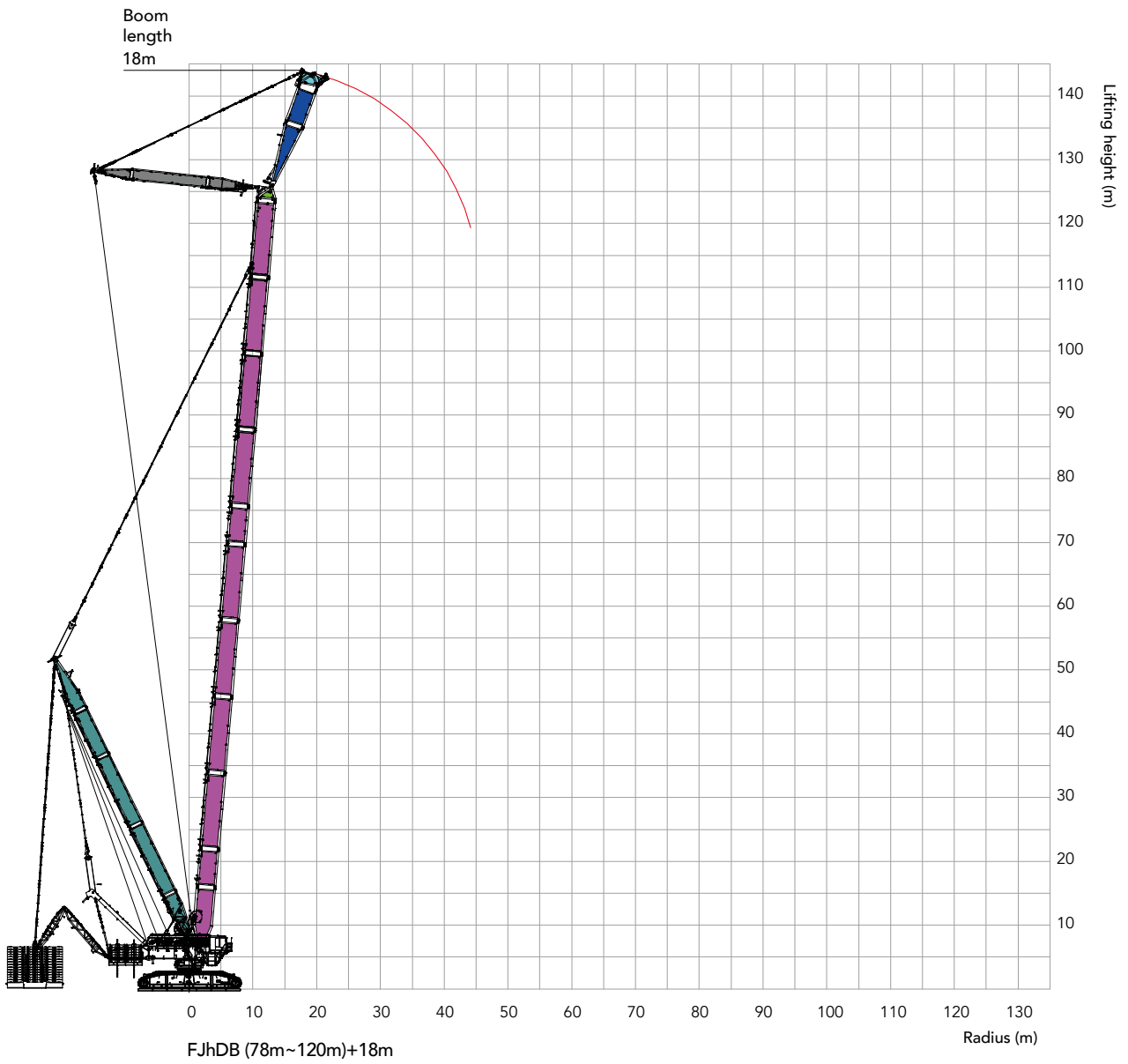

Unit: t

### Load chart of FJhDB configuration

FJhDB configuration									
Superlift radius 30m, superlift CW 1160t, rear CW 340t, carbody CW 89t									
Radius (m)	Boom length (m)								Radius (m)
	78	84	90	96	102	108	114	120	
22	823	725	647						22
24	832	734	651	580	521				24
26	845	738	658	586	522	466	418	376	26
28	856	745	660	587	527	470	421	376	28
30	866	751	665	592	527	470	424	378	30
32	876	752	670	596	531	473	424	380	32
34	884	761	674	596	534	475	426	382	34
36	863	765	677	599	536	477	427	383	36
38	853	768	680	603	538	479	429	384	38
40	803	749	683	605	540	481	430	385	40
44	714	706	655	612	543	483	432	386	44
48	639	634	624	578	545	487	433	385	48
52	610	573	565	556	512	488	435	380	52
56	550	551	514	507	496	455	430	377	56
60	498	501	468	463	454	444	406	372	60
64	481	456	455	424	417	408	398	362	64
68	436	415	416	415	383	376	367	357	68
72	395	405	381	381	377	347	339	330	72
76	382	368	374	350	347	343	313	305	76
80	346	353	342	345	320	317	311	282	80
84	331	327	311	317	294	292	288	261	84
88	297	294	302	290	292	269	266	261	88
92	271	285	277	279	268	269	245	241	92
96	219	265	263	260	244	247	246	223	96
100		224	241	235	239	226	227	205	100
104			220	226	220	220	208	207	104
108			177	211	208	205	201	190	108
112				180	192	185	187	173	112
116					175	178	171	170	116
120					138	165	162	158	120
124						140	150	147	124
128							135	136	128
132							103	125	132
136								103	136



## Zhejiang Sany Equipment Co.,LTD

SANY Crawler Crane Industrial Park, No. 2188 Daishan Road, Wuxing District, Huzhou City,  
Zhejiang Province, P. R. China Zip 313028  
Consulting [sanycrane@sanygroup.com](mailto:sanycrane@sanygroup.com) (Crane BU) / [crd@sany.com.cn](mailto:crd@sany.com.cn) (IHQ)  
After-sales Service 0086-400 6098 318

**Reminder:**

Any change in the technical parameters and configuration due to product modification or upgrade may occur without prior notice.  
The machine in the picture may include additional equipment. This brochure is for reference only, and goods in kind shall prevail.  
Copyright at SANY. No part of this brochure may be copied or used for any purpose without written approval from SANY.

© Edited in March 2023

